

Undergraduate Common Entrance Examination for Design

UCEED 2016



Indian Institute of Technology, Bombay

www.uceed.in

Paper Specific Instructions

1. The examination is of 3 hours duration. There are in total 80 questions carrying a total of 300 marks. The paper is divided into three sections, **A**, **B** and **C**. All sections are compulsory. Questions in each section are of different types.
2. **Section A (80 Marks)** contains a total of 20 **Numerical Answer Type (NAT)** questions. For each question, the answer is a real number that needs to be entered using the virtual keyboard on the monitor. No choices will be shown for these questions. There is **NEGATIVE** marking for this section. Each correct answer will be awarded 4 marks and each wrong answer will receive -1 (minus 1) mark. Questions not attempted will be given zero marks. Questions from 1 to 20 belong to this section.
3. **Section B (100 Marks)** contains a total of 20 **Multiple Select Questions (MSQ)**. Each question may have **one or more than one correct choice(s)** out of the four given choices. A candidate gets 5 marks only if **ALL** the correct answers and **NO** wrong answers are selected for each question. There is **NEGATIVE** marking for this section. Each incorrectly answered question will receive -0.5 (minus 0.5) marks. Questions not attempted will be given zero marks. Questions from 21 to 40 belong to this section.
4. **Section C (120 Marks)** contains a total of 40 **Multiple Choice Questions (MCQ)**. Each question has four choices out of which **ONLY ONE** is the correct answer. There is **NEGATIVE** marking for this section. Each correct answer will be awarded 3 marks and each wrong answer will receive -1 (minus 1) mark. Questions not attempted will be given zero marks. Questions from 41 to 80 belong to this section.
5. Calculators, charts, graph sheets, tables, cellular phone and/or other electronic gadgets are **NOT** allowed in the examination hall.
6. Papers will be provided for rough work.

Section A: Numerical Answer Type Questions

This section contains a total of 20 Numerical Answer Type (NAT) questions. For each question, the answer is a real number that needs to be entered using the virtual keyboard on the monitor. No choices will be shown for these questions. There is NEGATIVE marking for this section. Each correct answer will be awarded 4 marks and each wrong answer will receive -1 (minus 1) mark. Questions not attempted will be given zero marks. Questions from 1 to 20 belong to this section.

1. A pyramid with a base side 6 cm and height 7 cm is merged with a cube of length 5 cm such that the centroid of the cube matches with the centre of the base of the pyramid. The base of the pyramid is parallel to the base of the cube and the edges of the base of the pyramid are parallel to the sides of the cube. Count the number surfaces in the resulting solid.
2. How many different types of symbols appear in the figure given below?

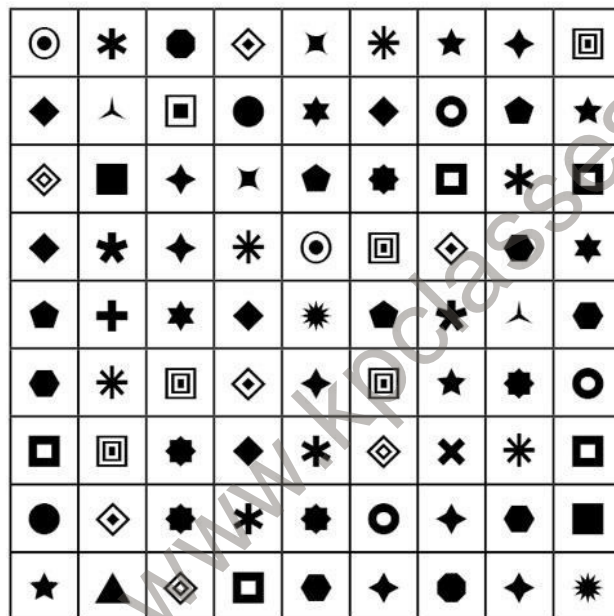

3. The numbers in the hexagon groups are arranged in a particular order. Find the number which would replace the question mark.

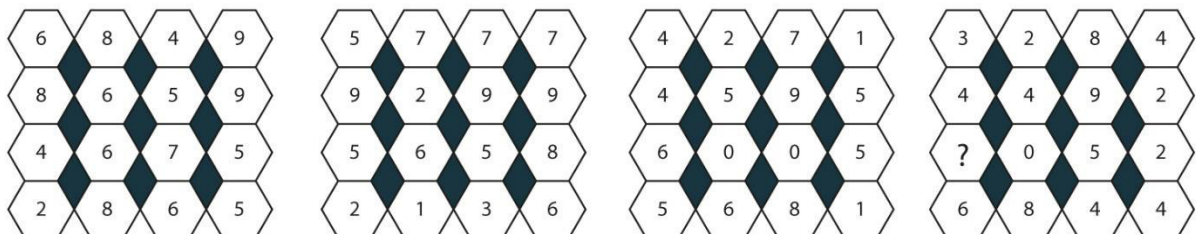

4. What is the maximum number of equilateral triangles of side 3 cm that can be fitted in a large equilateral triangle with length 11.2 cm?

5. The figure given below is to be cloned twice. The first clone on the right is to be reflected across the OP axis. The second clone on the left is to be reflected across the MN axis. The resultant figure is then to be cloned and reflected across the QR axis. Count the number of triangles in the final figure.

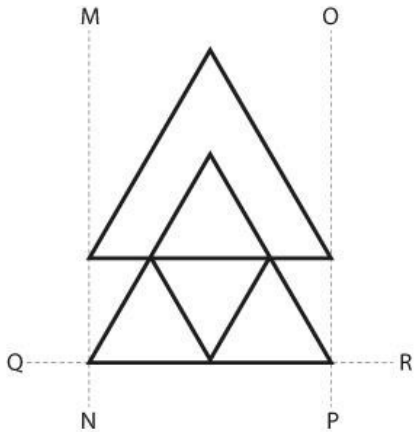

6. A company account book reveals the following figures:

Sales	2,35,126
Gross Profit	68,799
Administrative Expenses	2,456
Selling Expenses	4,789

Calculate the Operating Profit Ratio of the company.

7. How many different ways are there to get from Tile A to Tile I without visiting a tile more than once, if only horizontal and vertical movements are allowed?

G	H	I
D	E	F
A	B	C

8. There are some men and some women in a group. Each person shakes hands with exactly one other person in the entire group. After this round of handshakes, eight men and four women find that they shook hands with someone of the same sex. The total number of handshakes exchanged in the entire group is 87. At most how many women can there possibly be in this group?
9. It is 12 o'clock, and the hour and minute hands are aligned exactly one over the other. Both hands move continuously. After how many minutes will they meet again?

10. At most how many spheres of the same size can be placed around a same size sphere at the centre so that they all simultaneously touch the sphere at the centre?
11. A water tank of dimensions 20 cm x 5 cm x 10 cm has 307 cc water in it. A few bricks, each of dimensions 5 cm x 2 cm x 1 cm are fully submerged in the tank. Each brick absorbs 30% of its own volume of water. Just enough bricks are put in, such that the water level rises to completely fill the tank. How many bricks were put in the tank?
12. Count the total number of black diamonds in the given pattern.

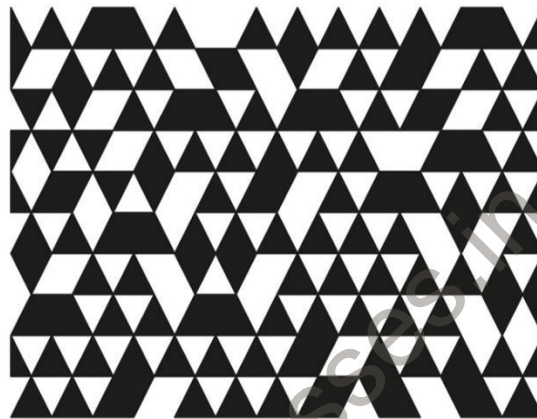

13. How many pages of size 21 cm x 25 cm can be made from a roll of 48 m x 1.2 m paper? Assume the pages are perfectly cut edge to edge.
14. How many tree trunks are there in the given figure?

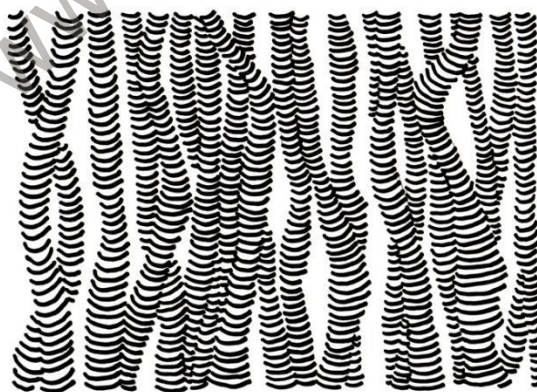

15. Shown below is a quadrant of a disc with cut-outs. Find the total number of cut-outs in the complete disc.

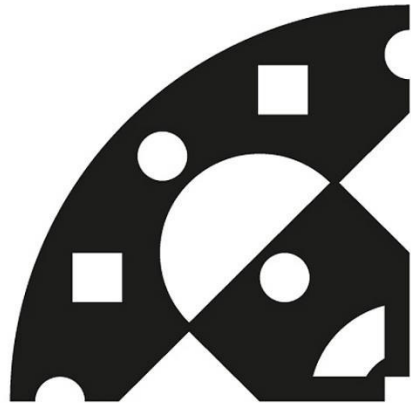

16. Count the number of people in this picture who are wearing spectacles.



17. You have been given a calculator that looks as in the image below. Given that you are allowed a total of only 6 key entries of which you MUST use at least one key entry for an operator and another key entry for the 'equals to' symbol, what is the largest number you can calculate?

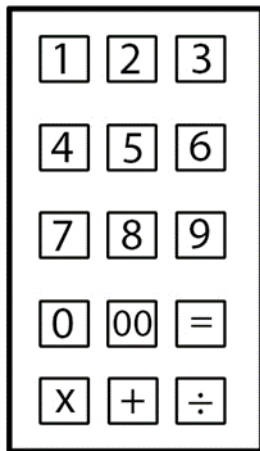

18. Count the number of fonts used in the given set of words.

amazing discussion worried sampled entrance
happily demarcate **deployed** canine metal
relinquish estate **wavelength** cautiously
temporary lavender sandalwood workable
transfer patient karmic safety fantastic
encourage **delightful** greetings achievement.

19. There are a host of HTTP codes which communicate different server messages: 404 for "not found", 403 for "forbidden" and so on. Recently there has been a proposal to assign a code for "censored/censorship" in honour of the author Ray Bradbury. What is the proposed code?
20. Two friends, one on a bike and the other in a car, arrive together at a parking lot. The chance that the one in the car will find a parking space is 0.1, and the one on the bike not finding a parking space is 0.1. What is the probability that only one of them finds a parking space?

Section B: Multiple Selection Questions

This section contains a total of 20 Multiple Select Questions (MSQ). Each question may have one or more than one correct choice(s) out of the four given choices. A candidate gets 5 marks only if ALL the correct answers and NO wrong answers are selected for each question. There is NEGATIVE marking for this section. Each incorrectly answered question will receive -0.5 (minus 0.5) marks. Questions not attempted will be given zero marks. Questions from 21 to 40 belong to this section.

21. Select all statements about the Silk Route that are TRUE:

- A. The Silk Route derives its name from the lucrative trade in Indian silks carried out along its length, beginning from the 3rd century BCE.
- B. Some scholars prefer the term "Silk Routes" because the road included an extensive network of routes, even though few were more than rough caravan tracks.
- C. Soon after the Roman conquest of Egypt in 30 BCE, communications and trade between China, Southeast Asia, India, the Middle East, Africa and Europe blossomed on an unprecedented scale because of the Silk Route.
- D. The Buddhist movement was perhaps the first large-scale missionary movement in the history of world religions, and its transmission to the Mediterranean began via the Silk Route in the 1st century CE.

22. There are no precise rules about punctuation (Fowler lays out some general advice (as best he can under the complex circumstances of English prose (he points out, for example, that we possess only four stops (the comma, the semicolon, the colon and the period (the question mark and exclamation point are not, strictly speaking, stops; they are indicators of tone (oddly enough, the Greeks employed the semicolon for their question mark (it produces a strange sensation to read a Greek sentence which is a straightforward question: Why weepst thou; (instead of Why weepst thou? (and, of course, there are parentheses (which are surely a kind of punctuation making this whole matter much more complicated by having to count up the left-handed parentheses in order to be sure of closing with the right number (but if the parentheses were left out, with nothing to work with but the stops, we would have considerably more flexibility in the deploying of layers of meaning than if we tried to separate all the clauses by physical barriers (and in the latter case, while we might have more precision and exactitude for our meaning, we would lose the essential flavour of language, which is its wonderful ambiguity.

Which of the following statements is/are true of the paragraph above?

- A. The thesis statement of the above paragraph is that there are no precise rules about punctuation.
- B. The author asserts that the Greeks were confused about their punctuation; they used semicolons in place of question marks.
- C. The recursive nesting of subordinate clauses within parentheses in the above paragraph simplifies sentence structure and clarifies writing.
- D. The author argues that parentheses may offer the possibility of greater rigor and accuracy for our meaning, but they do so at the cost of a critical quality of language, which is its wonderful ambiguity.

23. It is now theoretically possible to recreate an identical creature from any animal or plant, from the DNA contained in the nucleus of any somatic cell. A single plant root-tip cell can be teased and seduced into conceiving a perfect copy of the whole plant; a frog's intestinal epithelial cell possesses the complete instructions needed for a new, same frog. If the technology were further advanced, you could do this with a human being, and there are now startled predictions all over the place that this will in fact be done, someday, in order to provide a version of immortality for carefully selected, especially valuable people.

The cloning of humans is on most of the lists of things to worry about from Science, along with behavior control, genetic engineering, transplanted heads, computer poetry, and the unrestrained growth of plastic flowers.

...

The public questions are obvious. Who is to be selected, and on what qualifications? How to handle the risks of misused technology, such as self-determined cloning by the rich and powerful but socially objectionable, or the cloning by governments of dumb, docile masses for the world's work? What will be the effect on all the uncloned rest of us of human sameness? After all, we've accustomed ourselves through hundreds of millennia to the continual exhilaration of uniqueness; each of us is totally different, in a fundamental sense, from all the other [seven] billion. Selfness is an essential fact of life. The thought of human nonselfness, precise sameness, is terrifying, when you think about it.

Which of the following statements is/are true of the paragraph above?

- A. The arc of this passage moves from the biological to the social and the metaphysical—connecting the concerns of cloning with issues of identity and self-hood.
 - B. The author takes the view that cloning broadens the understanding of humanness by making room for evolving modifications in human beings and societies.
 - C. The author believes that if they are not socially objectionable, the self-determined cloning by the rich and powerful would not be a misuse of technology.
 - D. Were cloning permitted, the author is tormented by the prospect of the loss of selfness or uniqueness which, according to him, is at the very core of our sense of self.
24. In a wildlife rescue and rehabilitation centre in the Northeast of India, there are six orphaned creatures—ages 1.5 months to 6 months—who are currently receiving care, and await release into the wild in due course. They are an elephant, a rhinoceros, a wild buffalo, a clouded leopard, a swamp deer, and a hog badger. They were found in four different kinds of perilous situations, including a flooded ditch, attacks by poachers that killed the mother, a river in spate, and dangerous proximity to human habitat. After a few weeks in the rescue centre, each creature demonstrated one characteristic trait that stood out above all others: one was mischievous, another aggressive, a third shy, the fourth retiring, one fretful and the last one frisky.

Three creatures were actively injured.

The wild buffalo, who was found in a flooded ditch, is aggressive.

The creatures found in the river in spate are the mischievous and the fretful ones.

One of the two found in the flooded ditch is actively injured, while two of the uninjured, but severely stressed were found in the river in spate and as a victim of attack by poachers, respectively.

The shy creature was rescued from close to human habitat.
 The swamp deer is fretful, and is actively injured.
 The rhinoceres was found in a flooded ditch, and the clouded leopard was a victim of attack by poachers.
 The elephant is mischievous and severely stressed.

Which of the following assertions is/are true?

- A. If the creature who has a retiring temperament is uninjured, then the frisky creature is a clouded leopard.
- B. The hog badger is shy, and was found close to human habitat.
- C. If the creature who is aggressive by temperament is actively injured, then so is the one who is, by nature, retiring.
- D. The elephant is uninjured.

25. From the options at bottom, select the Indian author/s writing in English whose works are represented below:

- i. Circle of Reason
- ii. Shadow Lines
- iii. Prison and Chocolate Cake
- iv. Nectar in a Sieve
- v. Roots and Shadows
- vi. That long silence

- A. Nayantara Sahgal
- B. Amitav Ghosh
- C. Namita Gokhale
- D. Shashi Deshpande

26. A recent survey among concertgoers found that smaller, older halls sound better for symphony orchestras, as compared to bigger, modern ones. What is/are the reason(s) for this?

- A. Smaller halls are better able to reflect bass notes from the side walls and the ceiling, which is an important factor in the quality of symphony sound.
- B. Old halls are a part of history and heritage, so people think they sound better.
- C. Old concert halls with good acoustics tend to get maintained and preserved, while ones with suboptimal acoustics get renovated or replaced.
- D. The atmosphere is more intimate in an older concert hall—visually as well as acoustically—because the concertgoer is relatively close to the musicians.

27. Identify which of the options given below can be folded to make the 3D object shown in the box.

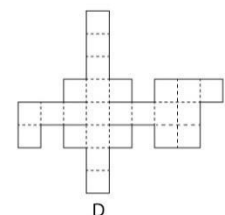
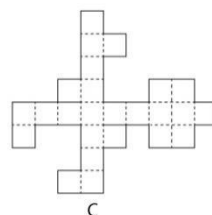
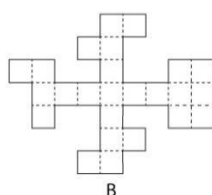
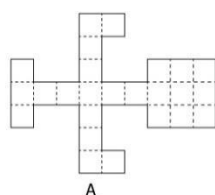
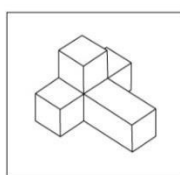

28. Which of the figures given below is/are simple rotations of the figure above.

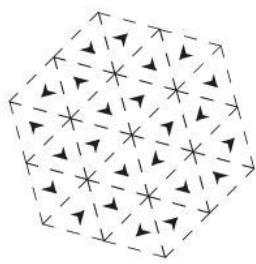
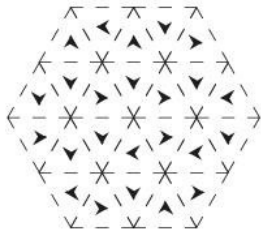

A

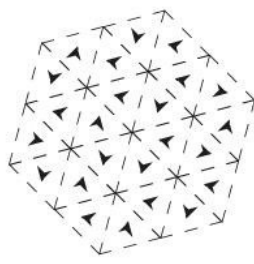

B

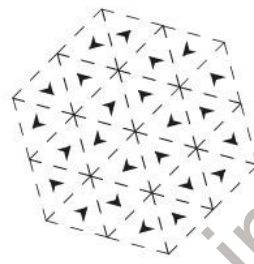

C

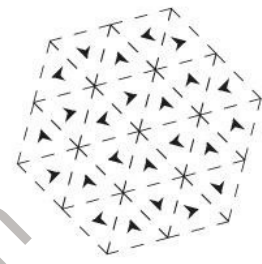

D

29. All doctors have to have a good understanding of the human body. Vijay has a good understanding of the human body. So he must be a cardiologist.

Which of the following options exhibit the exact same fallacy as the statement above.

- A. All dentists have to have a good understanding of human teeth. Santosh really has a good understanding of human teeth. So he must be a medical practitioner.
- B. All canines hunt in packs. Devil always hunts with his pack. So he must be a wolf.
- C. All good artists have a good sense of colour. Sunita has an excellent sense of colour. So Sunita must be a painter.
- D. All lecturers have to talk a lot. Vineet can talk for hours together. So he must be a teacher.

30. Select the artwork(s) which is/are attributed to Leonardo Da Vinci:



A



B



C



D

31. Which of the following is a/are river(s):

- A. Alakhnanda
- B. Parvati
- C. Vaigai
- D. Baralacha La

32. A square is cut into 7 pieces, as shown on the extreme left of the image. Identify which of the options can be made using all 7 pieces.

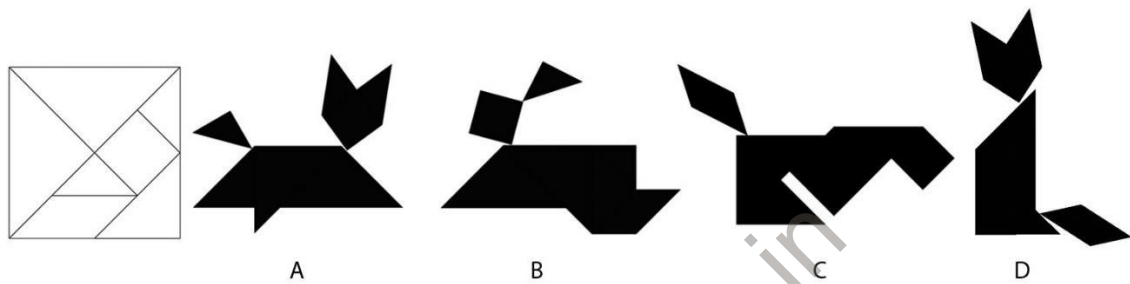

33. Identify which of the options given below can be folded to make the 3D object in the picture shown on the left.

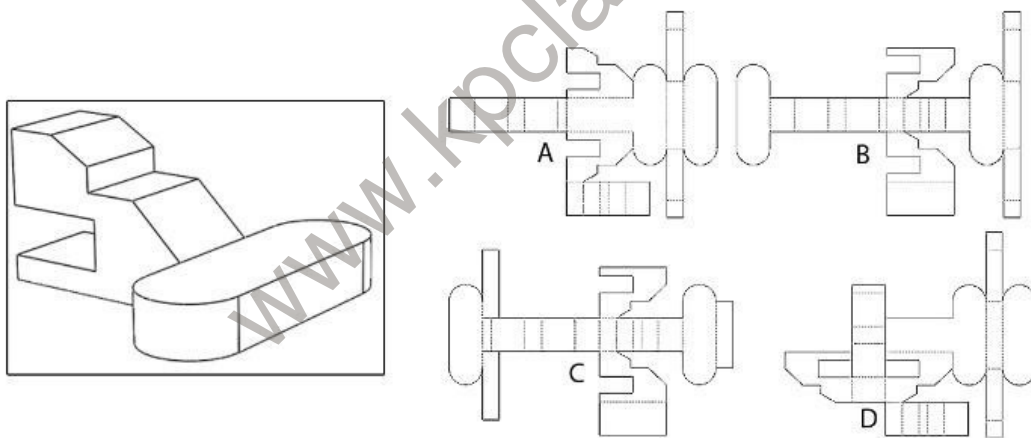

34. Shown in the image are schematic diagrams of folding chair structures. If the black dots indicate a hinged joint, identify the structure(s) that will work as a folding chair.

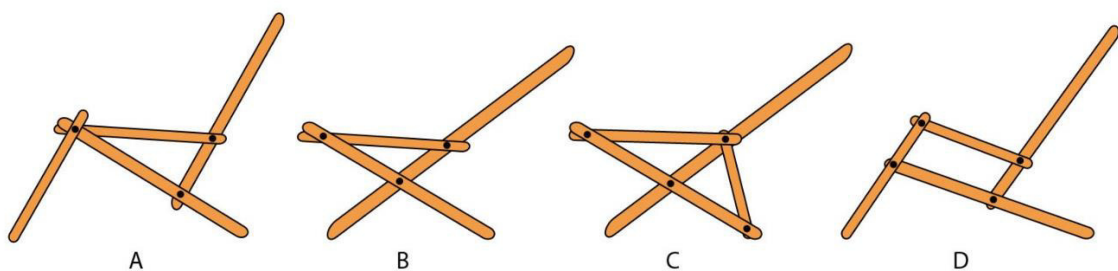

35. Shown below is a tyre tread mark. Choose the correct cross-section(s) that correspond(s) to the same tread mark. All cross sections are perpendicular to the tyre.

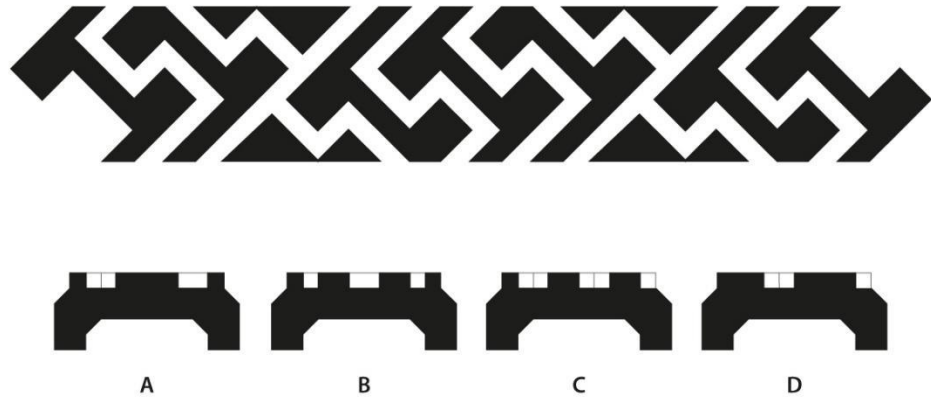

36. Shown below are three thematic population age-sex pyramids of three countries. The horizontal axis represents population in millions and the vertical axis represents age cohorts for both male and female population.

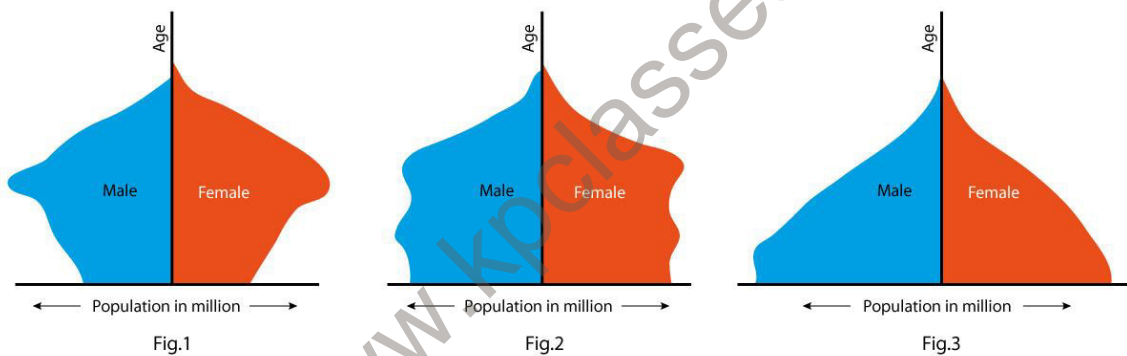

Which of the following statements is/are correct?

- A. Figure 2 depicts a low population growth, whereas it is high in figure 3.
- B. Figure 1 and figure 2 are from developed nations.
- C. Figure 1 depicts an aging society.
- D. Figure 3 depicts low life expectancy.

37. Figure 1 shows a specific pattern. From the options below, select the pattern that best matches the one in Figure 1.

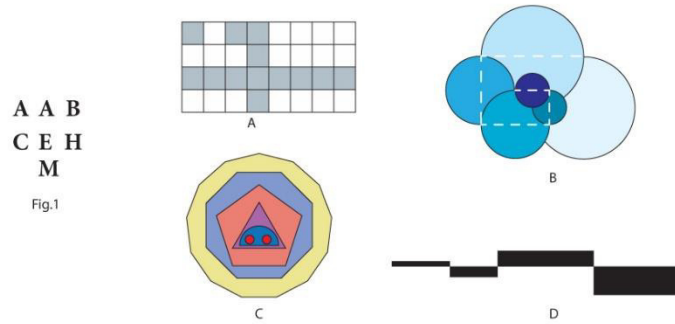

38. Figure 1 below depicts the locations of 50 families. They are affiliated with red and blue parties as shown. Five wards are to be drawn such that they are continuous and have equal number of families. The party that wins three or more of the five wards wins the election. Select the option(s) such that the blue party wins.

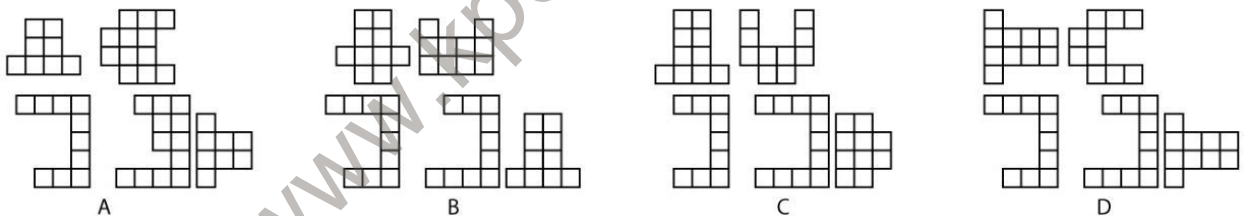
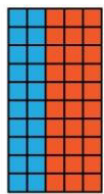

39. Given below is a structure made of coloured straws. Which of the views shown in the options belong(s) to the object in the box?

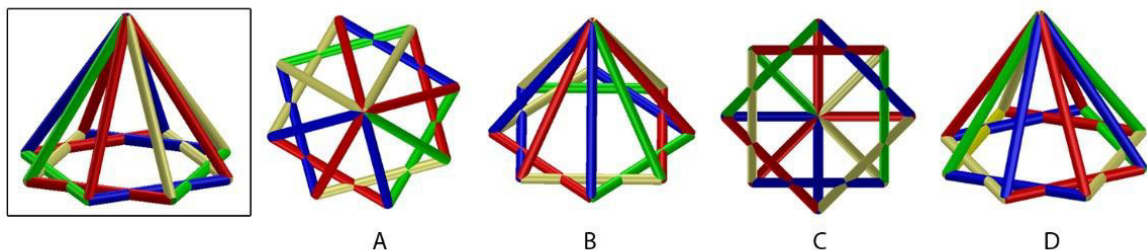

40. Holes have been drilled through a cube of size 10 x 10 x 10 units, as shown in the figure below. The number near each hole indicates its depth in units. All holes, except A, B, C, D and P, have been sealed on the surface after drilling. If water is poured through hole P, from which of the holes A, B, C, D will it find its way out?

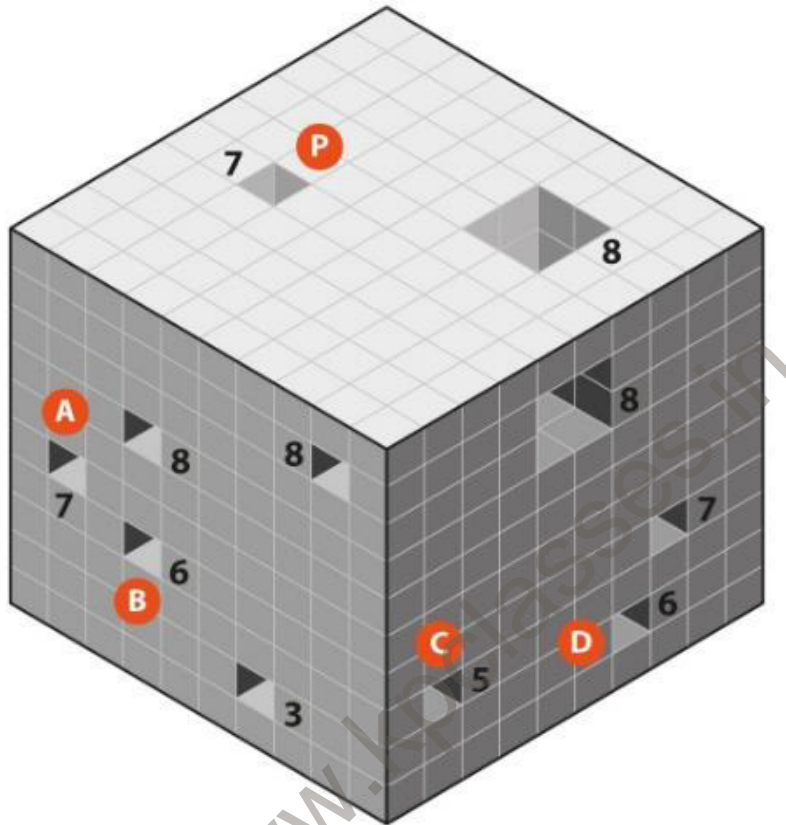

Section C: Multiple Choice Questions

This section contains a total of 40 Multiple Choice Questions (MCQ). Each question has four choices out of which ONLY ONE is the correct answer. There is NEGATIVE marking for this section. Each correct answer will be awarded 3 marks and each wrong answer will receive -1 (minus 1) mark. Questions not attempted will be given zero marks. Questions from 41 to 80 belong to this section.

41. Choose the option that comes next in the pattern sequence given below.

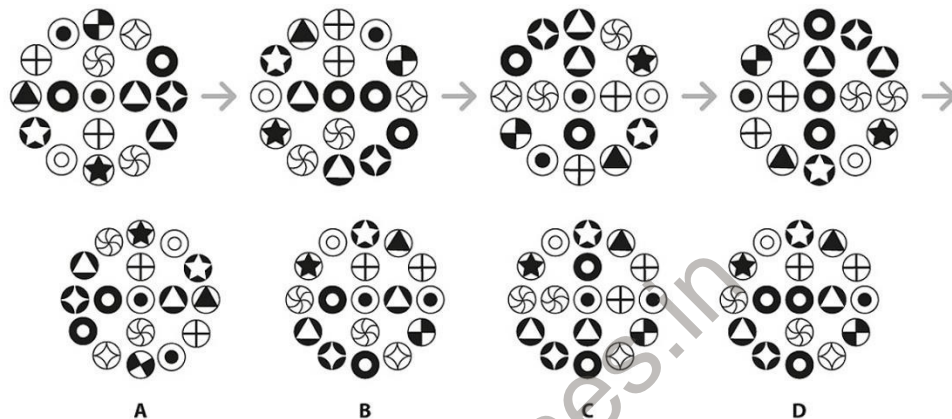

42. A polygonal shape moves through a series of numbered tiles as shown in the figure. The shape transforms itself at every tile according to rules given below. There can be one or more transformations on any given tile. Choose the resultant polygon from the options below.

- i. At even numbers one side gets added to the shape.
- ii. At odd numbers two sides get removed from the shape.
- iii. If the number is divisible by 2, one side gets added to the shape.
- iv. If the number is divisible by 3, one side is removed from the shape.
- v. On reaching the first prime number the colour of the shape changes to yellow.
- vi. On reaching a second prime number the colour of the shape changes to orange.

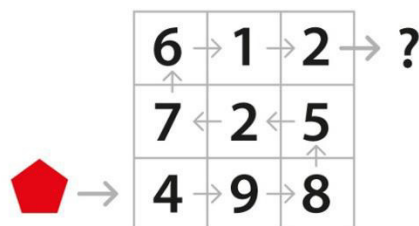

43. Three sides, each with circles and connecting lines, show three faces of a three-dimensional cube. (An example of such a cube is shown on the right.) Choose the correct option that corresponds to a cube with the three sides shown below.

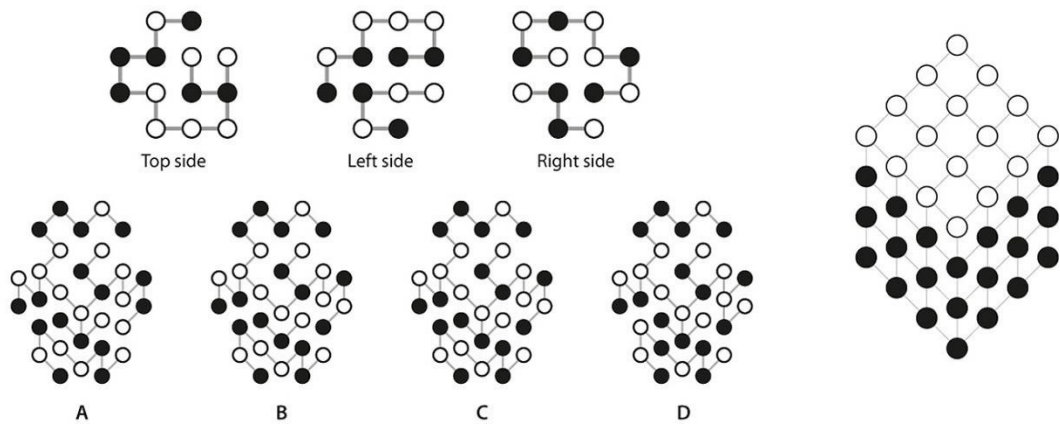

44. From the given options, choose the correct shoe sole that pairs with the sole shown on the left.



45. A circular palette with three pigment colours of the same quantity are mixed in the sequence shown below. Choose the correct resultant colour from the options.

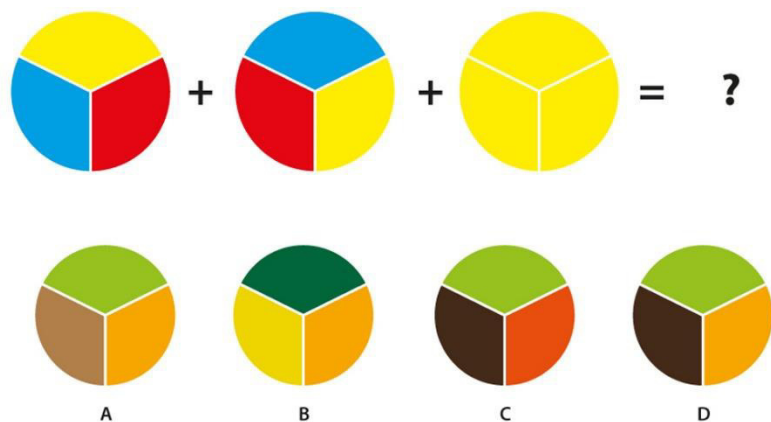

46. Figure 1 shows the top view of a lawn sprinkler. The Swastika-shaped arms rotate freely around a central pivot which supplies water to the arms. Water is sprinkled through the nozzles located at the end of the arms, which causes the sprinkler head to rotate. Now, imagine the whole sprinkler submerged under water and imagine the water being aspirated (suctioned) instead of being expelled. Which direction will the sprinkler head rotate?

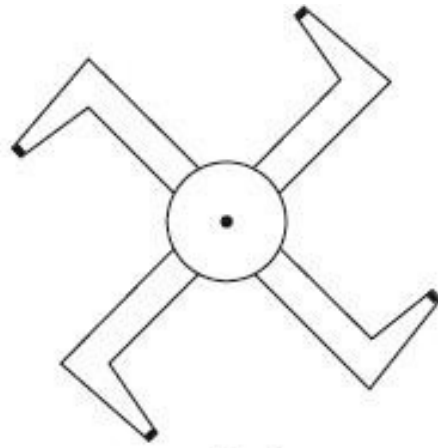
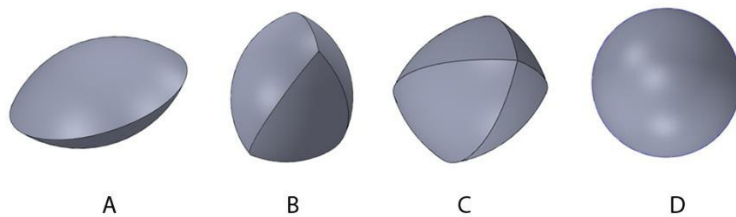
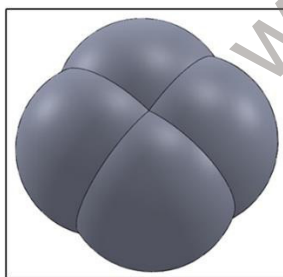

Fig. 1

- A. It will rotate anti-clockwise.
 B. It will rotate clockwise.
 C. It will not rotate at all.
 D. It will shuffle between clock-wise & anti-clock-wise rotations.
47. Four spheres are merged as shown in the box. After merging, the portion that is common to all of them (i.e. intersection) is removed. Identify the removed portion from the options given below.



48. Identify which of the musical instruments mentioned below use(s) the technique of hammering on strings to produce sounds: Santoor, Piano, Harmonium and Keyboard.

- A. Piano and Santoor.
 B. Only Santoor.
 C. Harmonium and Santoor.
 D. Keyboard and Piano.

49. A point P is placed at a distance of 12 cm from the centre of a circle of radius 17 cm. How many integer length chords of this circle can pass through P?

- A. 19
- B. 24
- C. 32
- D. 360

50. Given below are images drawn with the same set of equations but with different parameters. The parameters used to generate a figure are given below the figure. Identify the correct set of parameters which would generate the figure shown on the right.

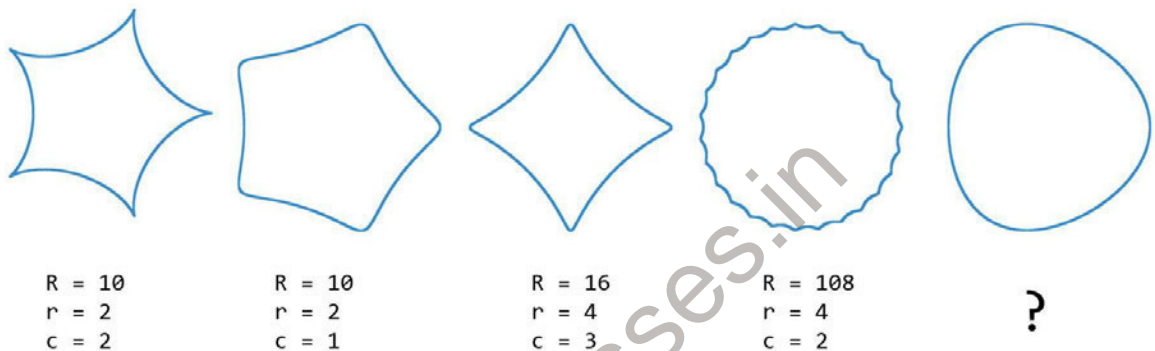

- A. $R = 24, r = 8, c = 0.9$
- B. $R = 24, r = 6, c = 0.9$
- C. $R = 24, r = 12, c = 1$
- D. $R = 24, r = 3, c = 3$

51. Choose the set of words that will correctly complete the following ten sentences from the word sets given in the answer options.

- I. The unnecessarily complex plot left me (bemused / amused).
- II. The dispute should be resolved by a (disinterested / uninterested) judge.
- III. A cup of hot coffee after a long day is (enervating / energizing).
- IV. She (depreciated / deprecated) his efforts.
- V. He (flaunted / flouted) the rules.
- VI. The new batsman (floundered / foundered) initially, but recovered after sometime.
- VII. By a (fortunate / fortuitous) coincidence, I met my old friend at the mall.
- VIII. The rebels were (interned / interred) in the military jail.
- IX. The artist had a (luxurious / luxuriant) imagination.
- X. His (simplistic / simple) answer suggested he wasn't familiar with the material.

- A. bemused, disinterested, energizing, deprecated, flouted, floundered, fortunate, interred, luxurious, simplistic.
- B. amused, uninterested, enervating, depreciated, flouted, foundered, fortuitous, interned, luxuriant, simple.

- C. bemused, disinterested, energizing, deprecated, flouted, floundered, fortuitous, interned, luxuriant, simplistic.
- D. amused, disinterested, enervating, depreciated, flaunted, foundered, fortuitous, interned, luxurious, simple.

52. Given below is a sequence of shapes arranged from left to right. There are eight rules which, when applied to the sequence, will transform it to one of the four options shown below. Identify the correct option.

Switch the 5th and 2nd shapes.

Change shapes with a cross inside a square with shapes with a cross inside a circle.

Replace all square shapes with their preceding circular shape.

Reverse the whole sequence.

Switch the 4th and 7th shapes.

Switch the 3rd and 6th shapes.

If 2 identical shapes occur consecutively, switch the 1st occurrence of the shape with the 1st shape in the whole sequence.

= ?

A.
 B.
 C.
 D.

53. Which of the options given below will correctly complete the series?

<div style="display: flex; justify-content: space-around;"> <div style="text-align: center;"> </div> <div style="text-align: center;"> </div> </div> <div style="display: flex; justify-content: space-around; margin-top: 10px;"> <div style="text-align: center;"> </div> <div style="text-align: center;"> </div> </div>	<div style="display: flex; justify-content: space-around;"> <div style="text-align: center;"> </div> <div style="text-align: center;"> </div> </div> <div style="display: flex; justify-content: space-around; margin-top: 10px;"> <div style="text-align: center;"> </div> <div style="text-align: center;"> </div> </div>
<div style="display: flex; justify-content: space-around;"> <div style="text-align: center;"> </div> <div style="text-align: center;"> </div> </div> <div style="display: flex; justify-content: space-around; margin-top: 10px;"> <div style="text-align: center;"> </div> <div style="text-align: center;"> </div> </div>	<div style="display: flex; justify-content: space-around;"> <div style="text-align: center;"> </div> <div style="text-align: center;"> </div> </div>







A

B

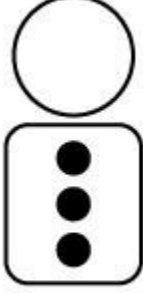
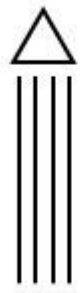
C

D

54. Five figures are coded with symbols, as shown below. From the given options, find the code for Figure 1.

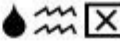
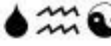
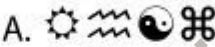
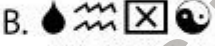



Fig.1

A. 

B. 

C. 

D. 

55. Identify the option that can be assembled to form Figure 1.

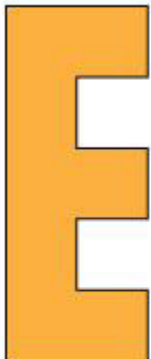
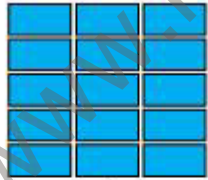



Fig.1



A



B



C

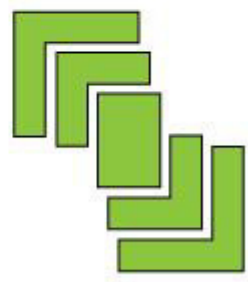

D

56. Read the following statements related to the economy.

- I. Devaluation of a currency means fixing the value of currency in multilateral consultation with the IMF, the World Bank, and major trading partners.
- II. The Law of Diminishing Marginal Utility states that as you keep on consuming a commodity continuously, the satisfaction derived from each subsequent unit will keep falling.
- III. Since human wants are unlimited and available resources are limited, a rational consumer will try to satisfy the least urgent needs which can be met within his/her income levels.
- IV. Budget deficit means the difference between all receipts and all expenditure.

Which of the above statements are TRUE?

- A. I & II
- B. II & III
- C. III & IV
- D. II & IV

57. Given below is a list of sixteen idioms connected with water. Each of the four options contains meanings of four randomly selected idioms from the list. Identify the option that contains correct meanings for all four of the chosen idioms.

- I. Fish out of water
- II. Tread water
- III. Come hell or high water
- IV. Watershed moment
- V. Pour oil in troubled waters
- VI. Throw the baby out with the bath water
- VII. Watering hole
- VIII. Head above water
- IX. Carry water for someone
- X. Water under the bridge
- XI. Uncharted waters
- XII. Muddy the waters
- XIII. Mouth watering
- XIV. In deep water
- XV. Dip your toe in the water
- XVI. Water down

- A. tavern, past, make progress, in trouble
- B. confuse or complicate the situation, to help, dilute, make matters worse
- C. tentative step, persistent in the face of difficulty, tasty, survive
- D. turning point, new territory, discard bad with good, misfit

58. Shown below are different handle positions of a hand tool. Identify which handle position gives the most comfortable hand posture for a downward to-and-fro motion.

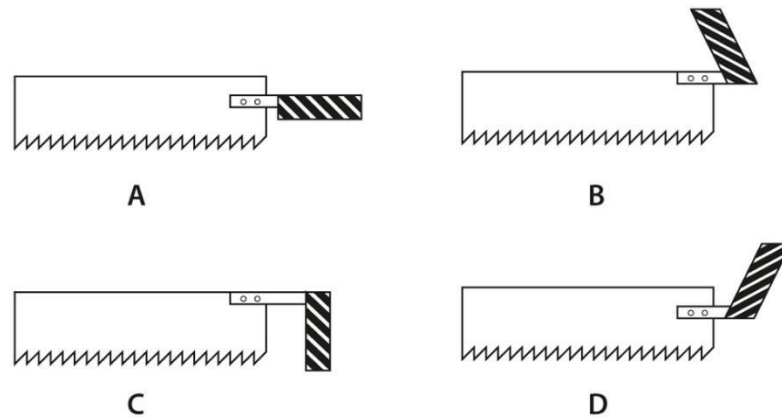

59. A pilot has to fly direct from Mumbai to Singapore. The departure of the flight from Mumbai airport is at dusk. Which colour goggles should the pilot be wearing at Mumbai airport for quickly adapting to darkness after take-off?

- A. Blue
- B. Black
- C. Red
- D. Brown

60. Here is a sketch of Alka with her mouth missing. Choose the correct sequence from the mouth shapes given below that will allow Alka to say "WELCOME TO UCEED".



Alka's Mouth Shapes:



- A. 5, 4, 2, 6, 1, 8, 3, 7
- B. 5, 4, 2, 8, 3, 1, 6, 7
- C. 5, 7, 4, 2, 1, 8, 3, 6
- D. 4, 2, 5, 1, 6, 8, 3, 7

61. If the following passage describing a situation was to be made into a comic page, match the numbered dialogues with the appropriate bubble according to comic book conventions:

Meanwhile at the college canteen, the manager was livid (1). "How many times have I told you to keep track of the orders?" (2), He screamed at the helpless waiter. Everyone stood still and watched. "What happened? Why is he screaming?" (3), I turned around to ask the person behind me in the queue at the counter. He bent forward and whispered, "Nothing new...he screams at everybody all the time. His staff hate him for that" (4). "Oh, that's not fair!" (5), I thought to myself, while the manager got louder and louder.

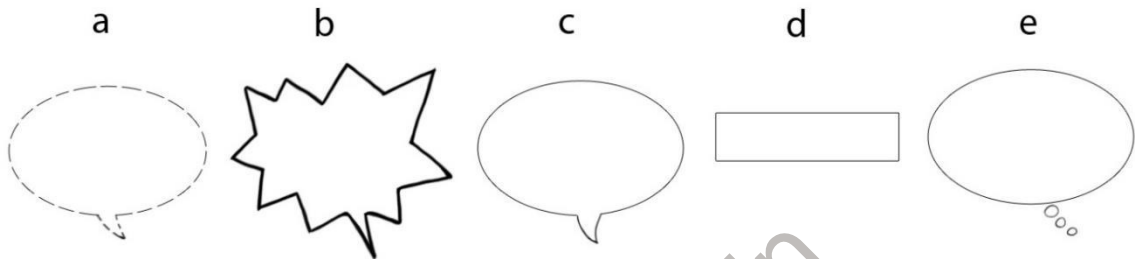

- A. 1-a, 2-b, 3-c, 4-e, 5-d
 B. 1-d, 2-b, 3-c, 4-a, 5-e
 C. 1-d, 2-b, 3-c, 4-e, 5-a
 D. 1-c, 2-a, 3-b, 4-d, 5-e

62. Arrange the following video formats according to their evolution:
 Beta, U-matic low band, VHS, Digibeta, U-matic Hi band

- A. VHS, U-matic low band, U-matic hi band, Beta, Digibeta
 B. U-matic low band, U-matic hi band, Beta, Digibeta, VHS
 C. Digibeta, Beta, U-matic hi band, U-matic low band, VHS
 D. Beta, Digibeta, U-matic low band, U-matic Hi band, VHS

63. Black & white photographs of the bin shown in Picture 1 were shot using red, yellow, and green colour filters. An additional black & white photograph was shot without any filter. From the given options, identify the photograph shot using red filter.

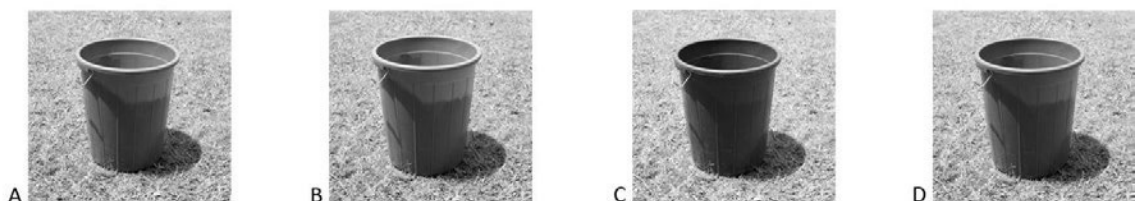

64. Match the cartoonist with his work.

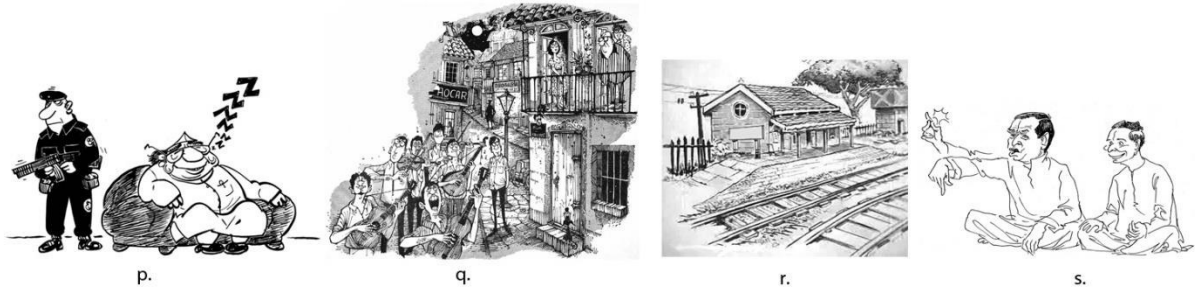

- i. Mario Miranda ii. Sudhir Tailang iii. Keshav iv. R.K.Laxman

- A. i-q, ii-p, iii-s, iv-r
 B. i-p, ii-s, iii-q, iv-r
 C. i-q, ii-p, iii-r, iv-s
 D. i-q, ii-s, iii-p, iv-r

65. Here are two sketches of Priyanka standing in front of a mirror. Spot the differences in the two sketches, and choose the correct number of differences from the options given below:



- A. 5
 B. 7
 C. 9
 D. None of the above

66. Given below are top views of a straight path along which a man moves in different ways. The dots represent the positions where his feet touch the ground. Choose the correct option that represents a dog running fast:

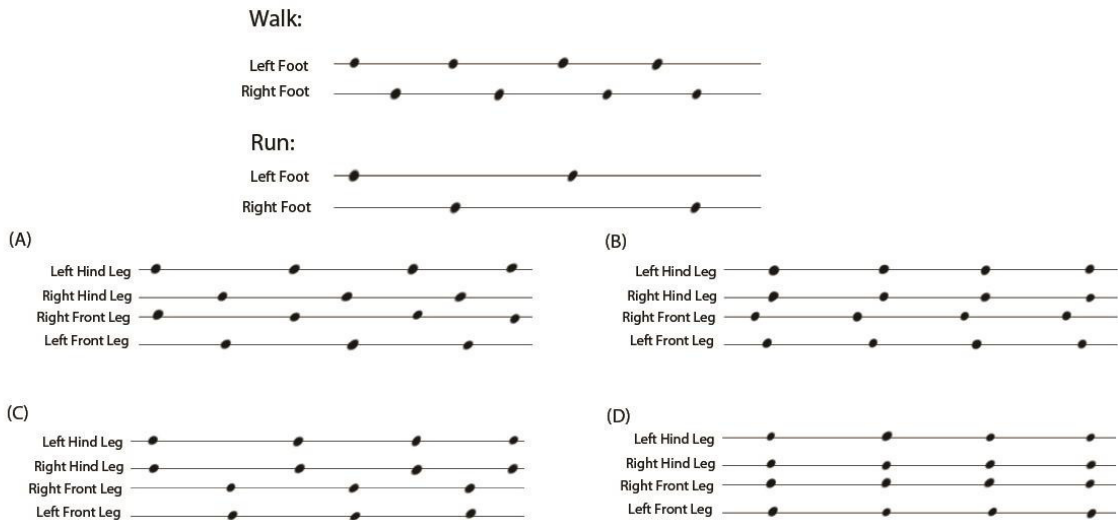

67. A colour picked in a paint software had the following values (RGB mode): Red=255, Green=100, Blue=0

The colour picked was:

- A. Grey
- B. Brown
- C. Yellow
- D. Orange

68. Read the text given below and answer the question that follows.

This (presence of benefits) together with (four) reasons
Is what the Tathāgata himself explained
In (the sūtra) requested by Subāhu
For the benefit of those inclined toward the lesser (paths).

If a person with a helpful intention
Thinks, "I shall merely relieve
The headaches of (a few) beings,"
(And this thought) is (already) endowed with boundless merit,

Then it is needless to mention that
Wishing to dispel the boundless misery of every single being,
And wishing for each of them
To accomplish boundless qualities (also carries boundless merit).

Do even fathers and mothers
Have such a benefiting intention?
Do the gods and sages
Or even Brahma have it?

Which philosophical tradition does this text belong to?

- A. Jainism
- B. Advaita Vedanta Hinduism
- C. Buddhism
- D. Dvaita Hinduism

69. Climate scientists tell us that such extremes of weather as the floods in Chennai or the acute lack of rainfall in large parts of India are due to a phenomenon called El Niño. The name comes from:

- A. "The boy child" or baby Jesus, because it happens around Christmas time.
- B. "The fiery storm"—for the hurricanes that occur in Central and South America from September through December.
- C. "The bubbling sea"—named by fishermen for the huge waves that accompany dramatically varying temperature patterns.
- D. "The death zone"—named by scientists for the large numbers of marine animals that die on the Pacific coasts of the Americas, because of the seas warming up.

70. The *Vikram and Vetala* series of stories, well-known across India, originate in the:

- A. Mahabhasya, perhaps of the 2nd century BCE
- B. Ubhayabhisarika, perhaps of the 4th-6th centuries CE
- C. Katha-sarita-sagara, perhaps of the 11th century CE
- D. Sukasaptati, perhaps of the 12th century CE

71. If a ball is placed in front of two mirrors at right angles to each other, as shown in the image, how many reflections will the ball generate?

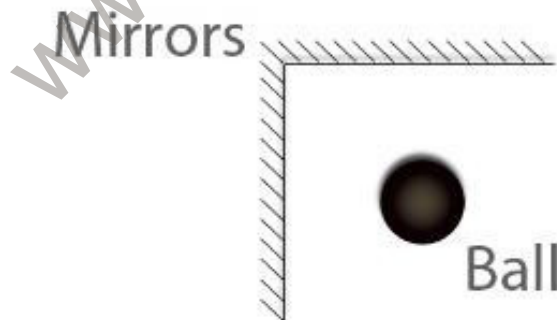

- A. 2
- B. 3
- C. 4
- D. 5

72. For the object shown in the box, which option identifies the position of its center of gravity correctly?

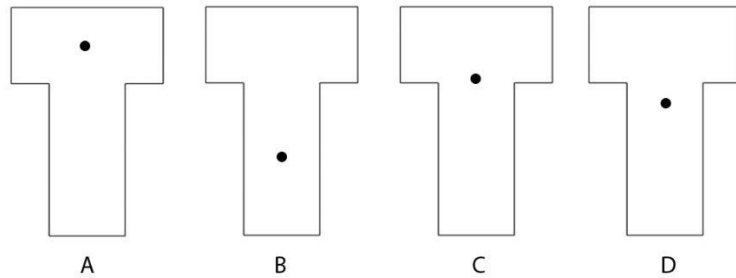
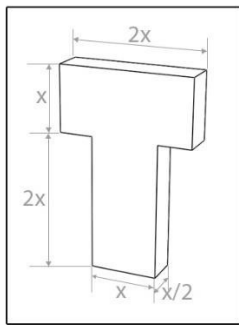

73. The image in the box shows a 3D object. From among the options below, select the one that shows the same object from a different view.

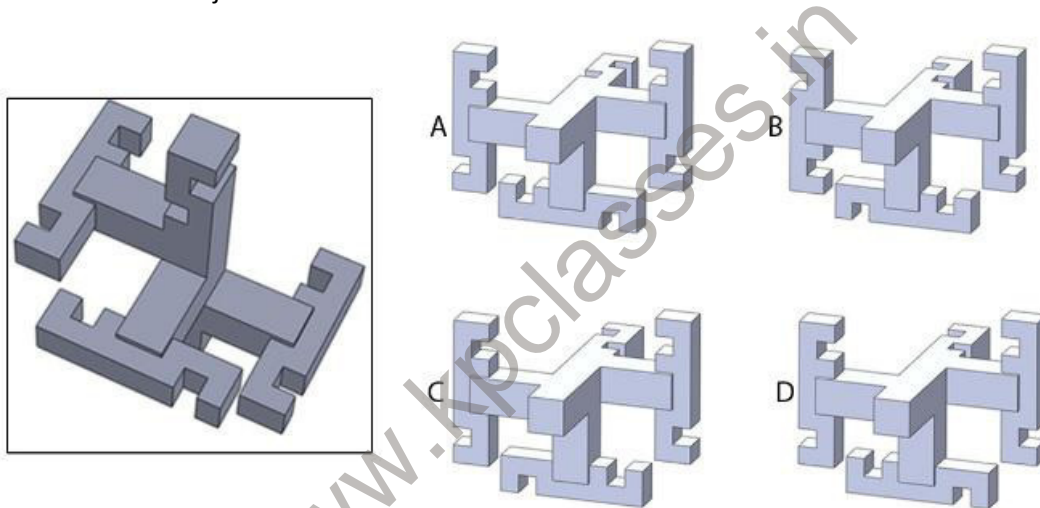

74. The circles in the image contain letters from F to V for purposes of identification of points. Directions are encoded in the statements below in such a way that NE stands for North-East, NNE for North-North-East, and so on. If all the following statements are true, select the correct representation of these statements from the given options.

- M is in NNE of G and L is in SSW of N
- P is in NW of K and U is in SSE of O
- V is in ESE of P and F is in NNW of S
- H is in SW of V and O is in NNE of J
- I is in SSE of N and Q is in SE of M

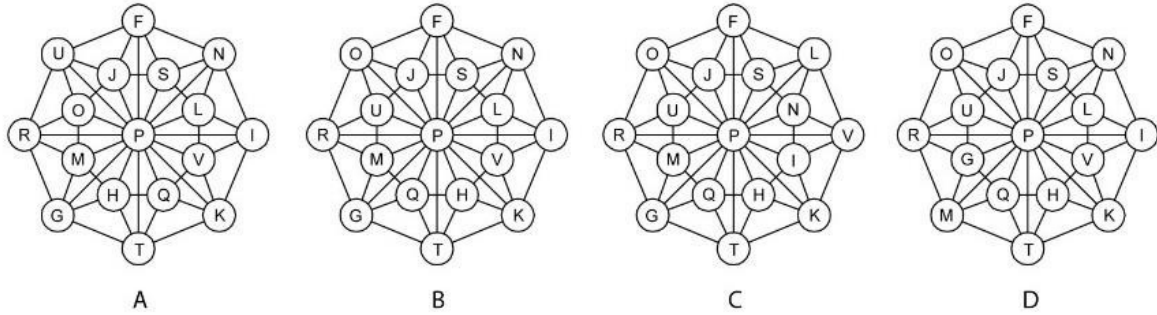

75. Select the option that has the correct match.

- | | |
|---------------------------|---|
| p) Ramsar Convention 1971 | i) Unite countries to pursue sustainable development |
| q) Vienna Convention 1981 | ii) Reduce GHG emissions |
| r) Montreal Protocol 1989 | iii) Conservation and sustainable utilisation of wetlands |
| s) Kyoto Protocol 1995 | iv) Protection of the ozone layer |

- A. s-ii & q-iii
 B. p-ii
 C. s-iv
 D. q-iv & r-i

76. There are four bins labelled 'i' to 'iv' as shown below. If the objects labelled 'p' to 'y' are to be thrown in their respective bins, which of the following combinations is correct.

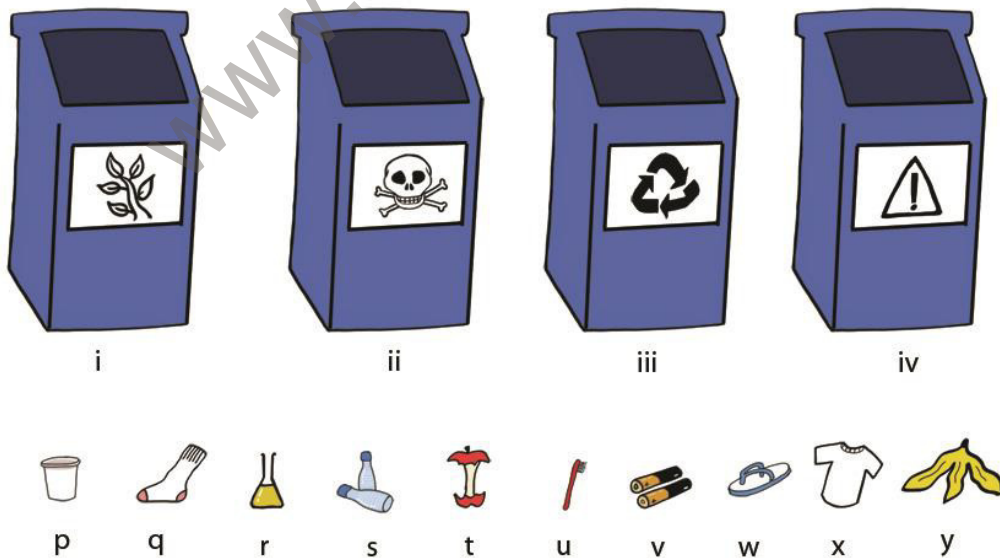

- A. p-i, q-iii, r-ii, u-i, x-ii.
 B. r-ii, t-i, x-iv, s-iii, p-iii.
 C. q-ii, u-i, y-i, v-ii, r-ii.
 D. w-iv, v-ii, x-iv, s-i.

77. Given below are some statements about rock-cut architecture. Which of these is TRUE?

- i. A lot of religious architecture was built or cut out of rock during the Vedic age; the remains of rudimentary sacrificial altars are evidence of the same.
- ii. Rock-cut temples were hollowed out of mountains or seams carved out of hard stone, but have more in common with conventional buildings constructed with blocks of dressed stone than with sculpture.
- iii. The transition from the earlier wooden to stone buildings resulted in “petrification” of forms; the heritage of the earlier periods was carefully transcribed into new materials.
- iv. The gigantic Kailasa temple at Ellora is the kind of rock-cut architecture—exactly as the rathas at Mamallapuram—where the monolithic building was carved straight out of living rock to create an occupiable space.

- A. i and ii
- B. ii and iii
- C. only iv
- D. only iii

78. Below is a set of pictures that show the variety of arches used in Islamic architecture in India from 7th to 17th centuries CE. Select the order in which the design of the arch developed.

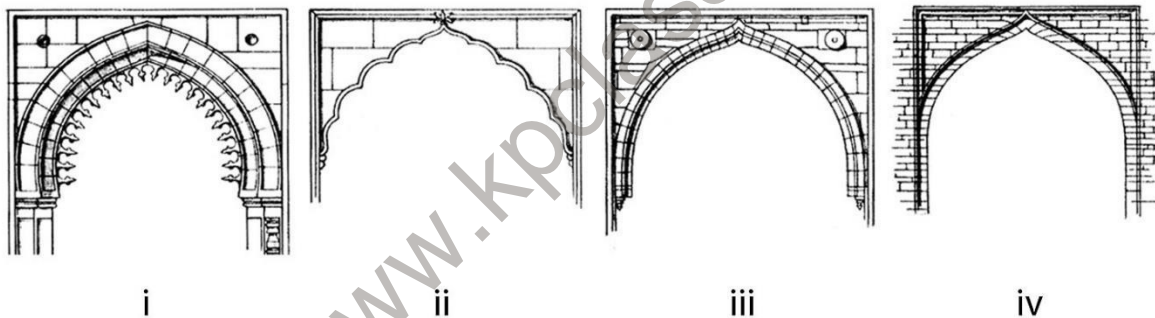

- A. iv, i, iii, ii
- B. iv, ii, iii, i
- C. ii, iv, i, iii
- D. iv, iii, ii, i

79. Which disease is caused by the deficiency of proteins?

- A. Kwashiorkor
- B. Marasmus
- C. Pellagra
- D. Anorexia

80. The word given below is written in a specific font. From the options, choose the word that belongs to the same font family.

அறிகின்ற

टेडा देवा केथा मेटा

A

B

C

D

END OF THE QUESTION PAPER

www.kpclasses.in

UCEED 2016 Final Answer Keys

Q01	19	Q31	ABC	Q61	B
Q02	26	Q32	BC	Q62	A
Q03	8	Q33	AD	Q63	C
Q04	11	Q34	D	Q64	A
Q05	50	Q35	ACD	Q65	B
Q06	0.26—0.27 or, 26—27	Q36	ABCD	Q66	B
Q07	12	Q37	C	Q67	D
Q08	85	Q38	D	Q68	C
Q09	65—66	Q39	ABC	Q69	A
Q10	12	Q40	ABD	Q70	C
Q11	99	Q41	B	Q71	B
Q12	12	Q42	D	Q72	D
Q13	1068	Q43	C	Q73	C
Q14	21—22	Q44	C	Q74	B
Q15	33	Q45	D	Q75	D
Q16	26	Q46	A	Q76	B
Q17	810000	Q47	C	Q77	D
Q18	10	Q48	A	Q78	A
Q19	451	Q49	A	Q79	A or B
Q20	0.82	Q50	A	Q80	B
Q21	BC	Q51	C		
Q22	AD	Q52	D		
Q23	AD	Q53	D		
Q24	BD	Q54	B		
Q25	ABD	Q55	C		
Q26	ABCD	Q56	D		
Q27	C	Q57	C		
Q28	ABD	Q58	B		
Q29	BC	Q59	C		
Q30	AC	Q60	A		

Q01-Q20 – NAT: Numerical Answer Type Questions (correct +4; incorrect –1)

Q21-Q40 – MSQ: Multiple Select Questions (correct +5; incorrect –0.5)

Q41-Q80 – MCQ: Multiple-Choice Questions (correct +3; incorrect –1)

Note: The sequence of these Answer Keys corresponds to the sequence of questions in the Question paper uploaded on the UCEED Website.